

**BTR**  **SYSTEMS**

GROUP  **BLACHOTRAPEZ**

# PRODUCT CATALOGUE

# The Best Type of Roofing

BTR  SYSTEMS

GROUP  BLACHOTRAPEZ

<b>WELCOME</b>	<b>05</b>
BANFF	06
TOFINO	08
TREND	10
ESTIMA	12
ENIGMA	14
MONT BLANC	16
TREMBLANT	18
WHISTLER	20
<b>ROOFING PANELS</b>	<b>22</b>
T-PANEL	24
Vancouver 25, Vancouver 38	26
<b>COLOURS AND FINISHES</b>	<b>28</b>
<b>THYSSENKRUPP STEEL AND COATING</b>	<b>29</b>
<b>ALUMINIUM STUCCO /MAT COARSE-GRAINED</b>	<b>30</b>
<b>COMING SOON</b>	<b>32</b>
<b>KROP - STEEL GUTTER SYSTEM</b>	<b>34</b>

At **BTR Systems**, we manufacture long-lasting, aesthetically pleasing and affordable steel roofing products that will protect your home for decades to come and will increase your home's value.

## HIGHEST QUALITY MATERIALS

With steel produced in Germany's Thyssenkrupp Steelworks, coated with industry leading ZM EcoProtect® and a 50 micron layer of Paldur Wrinkle Mat Plus, **BTR Systems** roofing panels are resistant to long-term wear, discolouring, and offer maximum corrosion resistance. **BTR Systems** modular steel roofing tiles will serve you reliably for generations.

Our modular steel panels are built to withstand UV rays, snow, hurricanes, and hail. **BTR Systems** roofing panels, installed from frosty Scandinavia to sunny Spain, have provided our customers with peace of mind and satisfaction.

## ASSORTMENT

At **BTR Systems**, we offer a wide variety of roofing panel profiles, finishes and colours to satisfy even the most demanding customers.

## EASY TO INSTALL

**BTR Systems** roofing products are engineered and manufactured with ease of installation in mind. With each panel weighing approximately 8.8lb (4kg), they are easy to handle and roof structures do not require any reinforcement. No specialty tools are required to install a **BTR Systems** roof.

## ACCESSORIES

At **BTR Systems**, we offer a full line of specialty steel roofing accessories designed specifically for our roofing system. With our selection of steel roofing accessories, roofing crews will not waste time on the job site cutting or forming specialty pieces. Our accessories include fascia edge pieces, chimney flashing, corner fittings and drip edge metal roof accessories.

## ENVIRONMENTALLY FRIENDLY

**BTR Systems** rooves are durable & eco-friendly. Our roofing products have more than twice the lifespan of conventional roofing products. Unlike tar, or bitumen shingles, our steel panels are 100% recyclable, earning us a C4 environmental classification, according to Europe's EN ISO 12944-2.

Our steel roofing tiles average less than 5% waste during installation, compared to industry norms greater than 10%.

## WARRANTY

At **BTR Systems**, our products are we backed with full manufacturer's warranty.



## BANFF

### TECHNICAL PARAMETERS

Overall width	~48 <sup>7</sup> / <sub>64</sub> "
Effective coverage width	46 <sup>1</sup> / <sub>64</sub> "
Steel sheet thickness	0 <sup>3</sup> / <sub>64</sub> "
Tile rib height	1 <sup>3</sup> / <sub>64</sub> "
Module length	14 <sup>8</sup> / <sub>64</sub> "
Profile height	0 <sup>15</sup> / <sub>64</sub> "

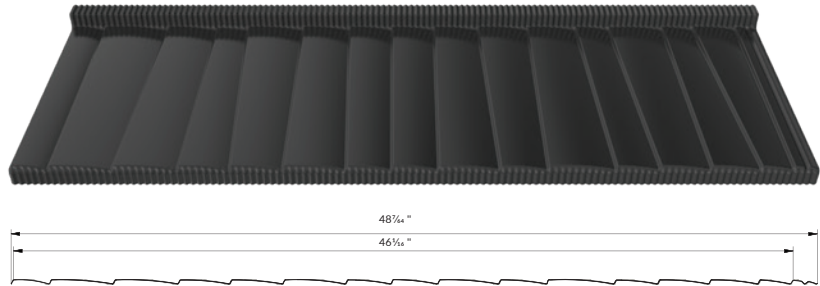

Available in the following finishes:



Pladur®  
Relief Wood



# BANFF STEEL SHINGLE

## Traditional Wooden Look in Steel

The Banff steel shingle panel is a unique product that resembles cedar shingles in texture and design. The Pladur Relief Wood coating technique, results in a unique visual effect, while guaranteeing unprecedented protection from the elements. Unlike wood products, the Banff steel shingle does not require costly maintenance and is simple to install, making it very economic and convenient for any home owner.





## TOFINO

### TECHNICAL PARAMETERS

Overall width	~48 <sup>27</sup> / <sub>64</sub> "
Effective coverage width	47 <sup>3</sup> / <sub>32</sub> "
Steel sheet thickness	0 <sup>1</sup> / <sub>64</sub> "
Tile rib height	1 <sup>3</sup> / <sub>16</sub> "
Module length	13 <sup>25</sup> / <sub>32</sub> "
Profile height	0 <sup>9</sup> / <sub>32</sub> "

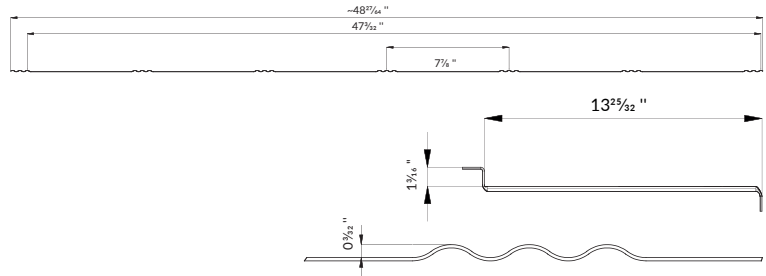

### Available in the following finishes:



Pladur® Wrinkle Mat

60

Pladur®  
Wrinkle Mat Plus



# TOFINO FLAT STEEL TILE

## The Contemporary Solution

Tofino steel tile panel, inspired by the "perfection shingle" is ideal for transitional and contemporary architectural styles. Embossed with the elegant linear triple rib design, Tofino steel tile may be applied both as roof coverage and facade siding.







## TREND

### TECHNICAL PARAMETERS

Overall width	~48 <sup>59</sup> / <sub>64</sub> "
Effective coverage width	45 <sup>59</sup> / <sub>64</sub> "
Thickness of the finished product (steel)	1/64 "
Tile rib height	1 3/16 "
Module length	13 <sup>29</sup> / <sub>32</sub> "
Profile height	2 5/64 "
Wavelength	9 1/64 "

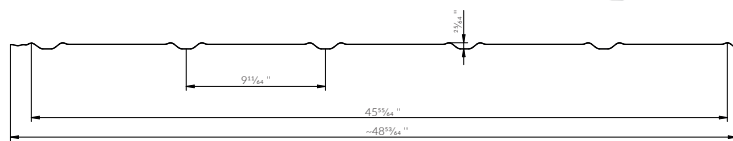
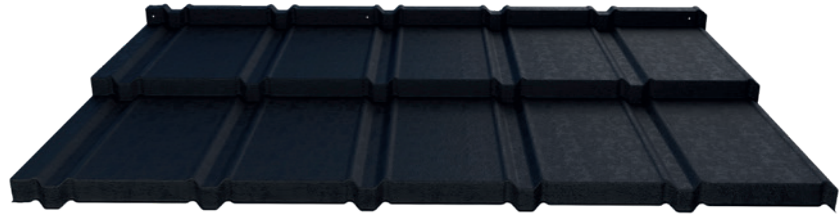

Available in the following coats:



Pladur® Wrinkle Mat

# TREND FLAT STEEL TILE

## Modernity and timelessness

The Trend flat sheet metal tile has been designed with attention to the smallest details. On the one hand, it is a reversal of trends that fits in with modern architectural structures. On the other hand, we are given a timeless flat surface. Modest elegance and unconventional character is a combination that will delight even the most demanding customers. It is flawless precision of workmanship and perfect appearance.





## ESTIMA

### TECHNICAL PARAMETERS

Overall width	~45 <sup>5</sup> / <sub>64</sub> "
Effective coverage width	46 <sup>5</sup> / <sub>64</sub> "
Steel sheet thickness	25 gauge 9steel 24 gauge (aluminum)
Tile rib height	1 <sup>3</sup> / <sub>8</sub> "
Module length	28 <sup>1</sup> / <sub>2</sub> "
Profile height	0 <sup>6</sup> / <sub>64</sub> "
Recommended length	193 45/64"

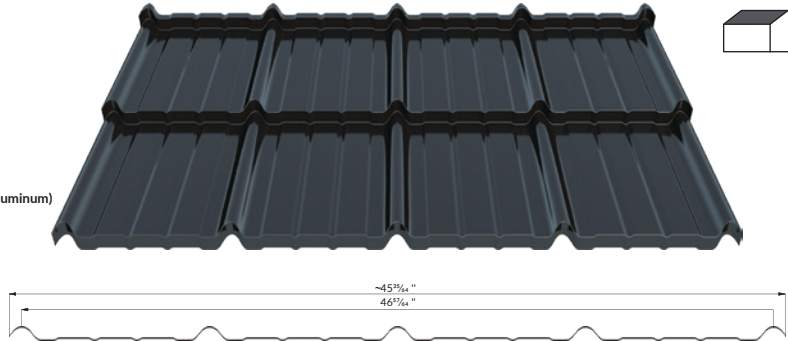

### Available in the following finishes:



Pladur® Wrinkle mat  
/Pladur® RAL Premium



Pladur®  
Wrinkle Mat Plus



Aluminium STUCCO  
/MAT Gruboziarnisty



Super Poliester  
Standard R-MAT

# ESTIMA STEEL TILE

## Out of Respect for Innovation

New, symmetrical flat tile, made of materials that guarantee quality, safety and comfort. Created for the most demanding customers. It is available in many colors and coatings, thanks to which it has wide configuration possibilities. Depending on the choice of protective coating, the manufacturer gives the product a warranty of up to 60 years. In a meeting with ESTIMA, the impression of solidity comes to mind involuntarily. The design will fit very well into both simple and more complicated roof constructions.





## ENIGMA

### TECHNICAL PARAMETERS

Overall width	~48 <sup>27</sup> / <sub>64</sub> "
Effective coverage width	47 <sup>32</sup> / <sub>32</sub> "
Steel sheet thickness	0 <sup>1</sup> / <sub>64</sub> "
Tile rib height	1 <sup>3</sup> / <sub>16</sub> "
Module length	13 <sup>25</sup> / <sub>32</sub> "
Profile height	0 <sup>7</sup> / <sub>32</sub> "

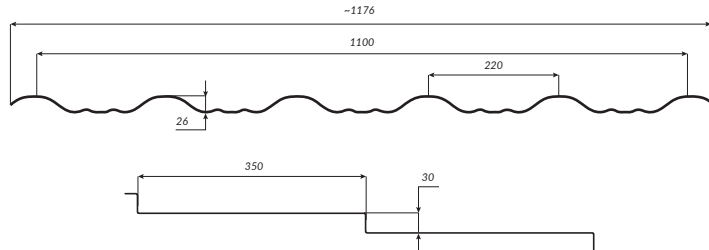

### Available in the following finishes:



Pladur® Wrinkle mat  
/Pladur® RAL Premium



Pladur®  
Wrinkle Mat Plus



Aluminium STUCCO  
/MAT Gruboziarnisty



Super Poliester  
Standard R-MAT

# ENIGMA STEEL TILE

## WE BROKE THE CODE TO THE EXCELLENCE

The laying method can be adapted to the specific roof and according to our own inspiration. The innovative technology of stiffening the sheets through the bottom shelf in combination with other product features makes it unrivalled on the market today. Enigma can surprise you even when you expect a surprise. The first positive shock comes as a combination of classics and modernity. Thanks to Safe Profiling System embossing combined with the Pladur Wrinkle Mat coating, customers receive as much as 60 years written warranty. The symmetrical Enigma profile is unique and particularly attractive in black and brick colors. The Enigma has been tailored to the needs of the most demanding roofers.





## MONT BLANC roof tile

### TECHNICAL PARAMETERS

Overall width	~47 <sup>53</sup> / <sub>64</sub> "
Effective coverage width	44 <sup>3</sup> / <sub>32</sub> "
Steel sheet thickness	0 <sup>1</sup> / <sub>64</sub> "
Recommended length	235 <sup>3</sup> / <sub>64</sub> "
Tile rib height	0 <sup>63</sup> / <sub>64</sub> / 1 <sup>1</sup> / <sub>16</sub> "
Module length	13 <sup>25</sup> / <sub>32</sub> "
Profile height	0 <sup>25</sup> / <sub>32</sub> "

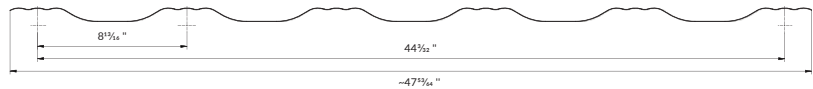

### Available in the following finishes:



Pladur® Wrinkle mat  
/Pladur® RAL Premium



Pladur®  
Wrinkle Mat Plus



Aluminium STUCCO  
/MAT Gruboziarnisty



Super Poliester  
Standard R-MAT

# MONT BLANC STEEL TILE

## European Clay Tile in Steel Panel

Mont Blanc tile panel interprets the high profile European clay tile in steel. This tile is graceful in form and appropriate for classic and traditional architectural styles. This exceptional product is distinguished by its high profile and unique triple rib, giving the roof a distinct and timeless character.

Unlike clay tiles, Mont Blanc steel tiles are light and do not require any roof structure reinforcement.







## TREMBLANT roof tile



### TECHNICAL PARAMETERS

Overall width	47 $\frac{1}{4}$ "
Effective coverage width	45 $\frac{5}{64}$ "
Steel sheet thickness	0 $\frac{7}{64}$ "
Recommended length	235 $\frac{3}{64}$ "
Tile rib height	1 $\frac{1}{64}$ "
Module length	13 $\frac{3}{32}$ "
Profile height	0 $\frac{5}{64}$ "

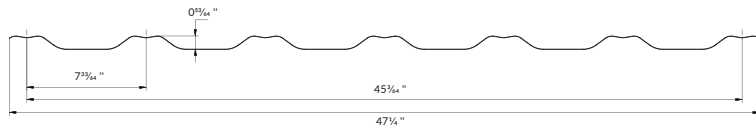

### Available in the following finishes:



Pladur® Wrinkle mat  
/Pladur® RAL Premium



Pladur®  
Wrinkle Mat Plus



Aluminium STUCCO  
/MAT Gruboziarnisty



Super Poliester  
Standard R-MAT

# TREMBLANT STEEL TILE

## Classic Clay Tile in Steel Panel

Tremblant tile panel interprets the classic clay tile in solid steel. This lower profile steel tile blends traditional contours with modern design, making it ideal for a range of classic architectural styles.

Unlike clay tiles, Tremblant steel tiles are light and do not require any roof structure reinforcement.





## WHISTLER



### TECHNICAL PARAMETERS

Overall width	~47 <sup>4</sup> / <sub>64</sub> "
Effective coverage width	45 <sup>3</sup> / <sub>32</sub> "
Steel sheet thickness	0 <sup>3</sup> / <sub>64</sub> "
Recommended length	max 235 <sup>5</sup> / <sub>64</sub> "
Tile rib height	1 <sup>3</sup> / <sub>16</sub> / 1 <sup>1</sup> / <sub>6</sub> "
Module length	13 <sup>25</sup> / <sub>32</sub> "
Profile height	0 <sup>3</sup> / <sub>4</sub> "

Size 30/35

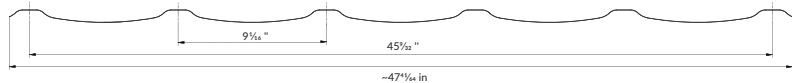

### Available in the following finishes:



Pladur® Wrinkle mat  
/Pladur® RAL Premium

60

Pladur®  
Wrinkle Mat Plus



Aluminium STUCCO  
/MAT Gruboziarnisty



Super Poliester  
Standard R-MAT

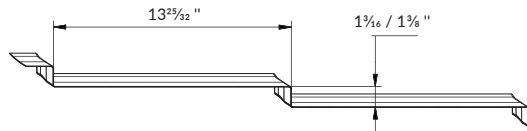

# WHISTLER

## European Slate Tile in Steel Panel

Torino tile panel interprets European slate tile design in steel. This slender and graceful in form design is appropriate for classic, transitional and contemporary architectural styles.

Unlike slate tiles, Whistler steel tiles are light and do not require any roof structure reinforcement.







# ROOF STANDING SEAM PANELS

## Traditional Wooden Look in Steel

"Standing Seam" panels are well known in the industry for their traditional "seam or welt" installation system. SOLID STEEL designers and engineers modernized this traditional product and are proud to introduce the Vancouver 25 and 38 steel panels. Through innovation and numerous technical improvements, SOLID STEEL modular panels are superior in appearance, ease of installation, and affordability.



## T-PANEL

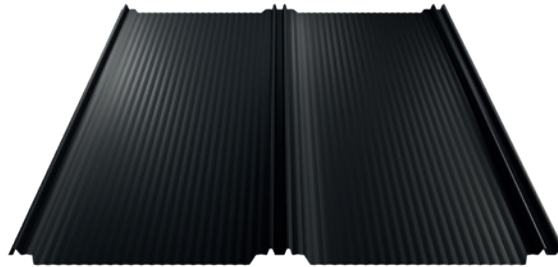

### TECHNICAL PARAMETERS

Overall width	~43 <sup>3</sup> / <sub>16</sub> "
Effective coverage width	41 <sup>7</sup> / <sub>32</sub> "
Thickness of the finished product (steel)	0 <sup>1</sup> / <sub>64</sub> "
Thickness of the finished product (aluminium)	0 <sup>7</sup> / <sub>32</sub> "
Profile depth	0 <sup>6</sup> / <sub>4</sub> "
Sheet length	3/4 <sup>6</sup> / <sub>64</sub> "

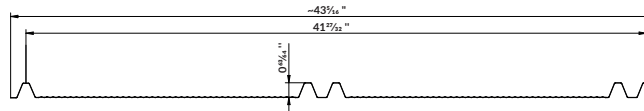

### Available in the following coats:



Pladur® Wrinkle Mat



Pladur®  
Relief IceCrystal



Pladur®  
Relief Textured Wood



60 Pladur®  
Wrinkle Mat Plus

# T-PANEL ROOFING PANEL

## Tailored to the needs

T-Panel is a breakthrough high-class flat roofing product. Tailored to the needs of a modern customer, it will perfectly fit into the surrounding architecture. The material used is high-quality steel from reputable suppliers. T-Panel is available, among others, in PREMIUM class coatings with the longest written guarantee of durability up to 60 years. It is a reliability of technical and aesthetic lifespan of the roof.





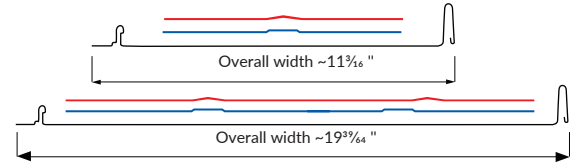
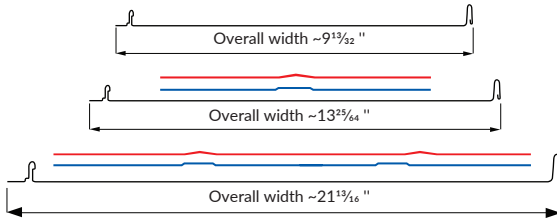
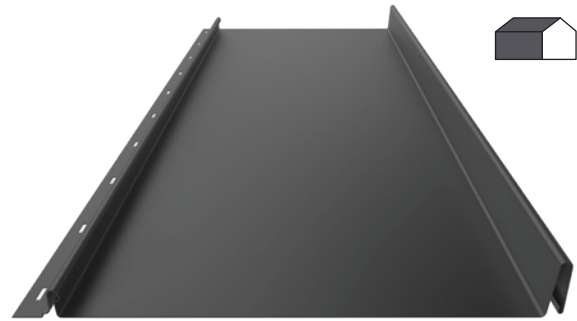
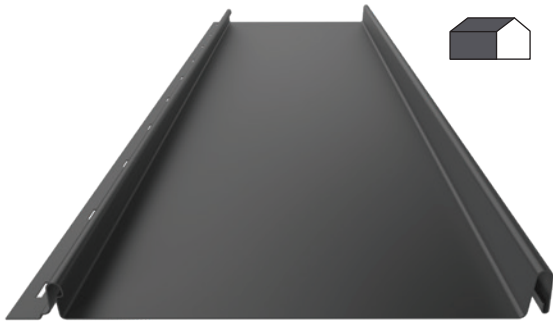

## Vancouver 25

Seam height	0 <sup>63</sup> / <sub>64</sub> "
Effective coverage width	20 <sup>33</sup> / <sub>64</sub> / 12 <sup>1</sup> / <sub>64</sub> / 8 <sup>5</sup> / <sub>64</sub> "
Overall width	~21 <sup>13</sup> / <sub>16</sub> / ~13 <sup>3</sup> / <sub>64</sub> / ~9 <sup>1</sup> / <sub>32</sub> "
Sheet thickness	0 <sup>7</sup> / <sub>64</sub> "
Sheet length	max 314 <sup>6</sup> / <sub>64</sub> " min 55 <sup>1</sup> / <sub>8</sub> "

Available in the following finishes:



Pladur® Wrinkle mat  
/Pladur® RAL Premium



Pladur®  
Wrinkle Mat Plus



Super Polyester  
Standard R-MAT

## Vancouver 38

Seam height	1 <sup>1</sup> / <sub>2</sub> "
Effective coverage width	19 <sup>33</sup> / <sub>64</sub> / 11 <sup>3</sup> / <sub>16</sub> "
Overall width	~19 <sup>33</sup> / <sub>64</sub> / ~11 <sup>3</sup> / <sub>16</sub> "
Sheet thickness	0 <sup>7</sup> / <sub>64</sub> "
Sheet length	max 314 <sup>6</sup> / <sub>64</sub> " min 55 <sup>1</sup> / <sub>8</sub> "

Available in the following finishes:



Pladur® Wrinkle mat  
/Pladur® RAL Premium



Pladur®  
Wrinkle Mat Plus



Super Polyester  
Standard R-MAT

ADDITIONAL OPTION: Ribs, Cutting – cutting option for folding, Cutting with folding – folding option for start piece

## VANCOUVER 25 and 38

Vancouver standing seam steel panels are produced and delivered in lengths up to 315 inches, or (8 meters) long. These steel panels are particularly well suited to contemporary architectural styles. Vancouver steel panels may also be applied as facade siding.





Pladur® Wrinkle mat



Pladur®  
Wrinkle Mat Plus



Pladur® Relief  
Textured Wood



Super Poliester  
Standard R-MAT



Aluminium STUCCO  
/MAT Coarse-grained



The printing technology does not allow for accurate reflection of coating colours, thus the presented colours are indicative and may differ from actual colours. The colours of samples are subject to production tolerance and may insignificantly differ from the material delivered to the construction site.

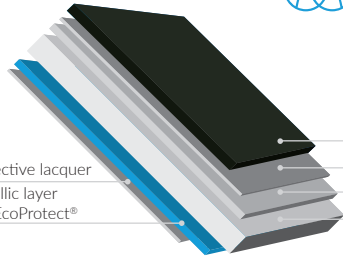

### Pladur® Wrinkle Mat Plus

- Decorative mat lacquer
- Protective lacquer
- Metallic layer ZM EcoProtect®
- Steel core

- Protective lacquer
- Metallic layer ZM EcoProtect®



**60** Pladur® Wrinkle Mat Plus  
GUARANTEE WRITTEN

**Pladur® Wrinkle Mat Plus** - coarse-grained, 2-layer coating system, in colours according to known colour schemes, with layer thickness of min. 50 microns.

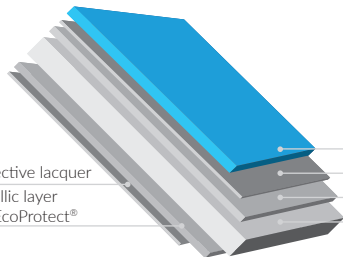

### Pladur® Wrinkle mat / Pladur® RAL Premium

- Decorative mat/gloss lacquer
- Protective lacquer
- Metallic layer ZM EcoProtect®
- Steel core

- Protective lacquer
- Metallic layer ZM EcoProtect®



**45** Pladur® Wrinkle mat / Pladur® RAL Premium  
TO YEARS GUARANTEE WRITTEN

**Pladur® Wrinkle mat** - thick-grain, double-layer coating system, with colours according to well-known patterns and min. coat thickness 35 microns. The sheets meet the requirements of class A2 in accordance with the Commission Decision 96/603/EC on fire protection and may be used in the corrosion category C4 according to the standard EN ISO 12944-2.

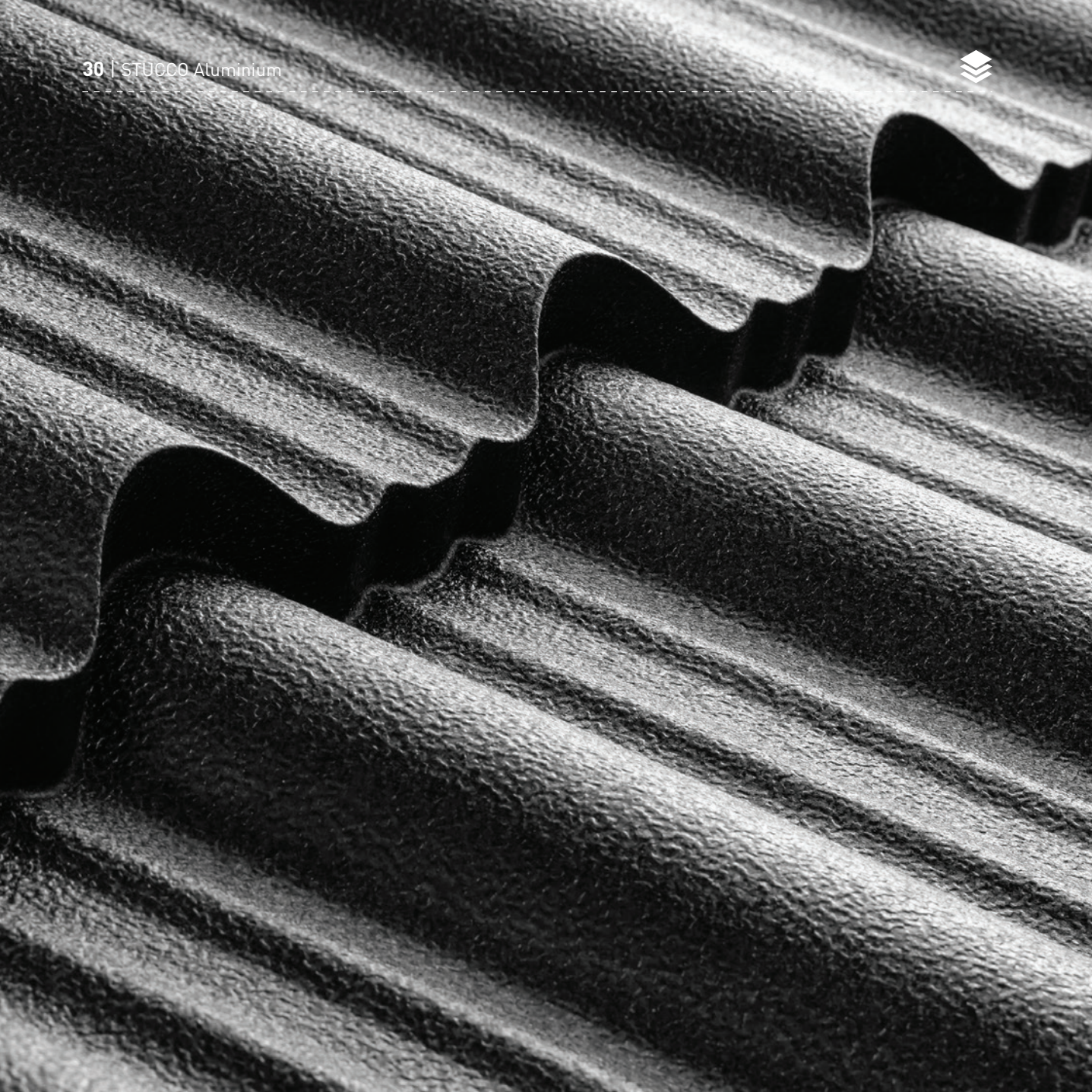



## Hydro

Top layer

Primer varnish

Aluminium core

Protective varnish

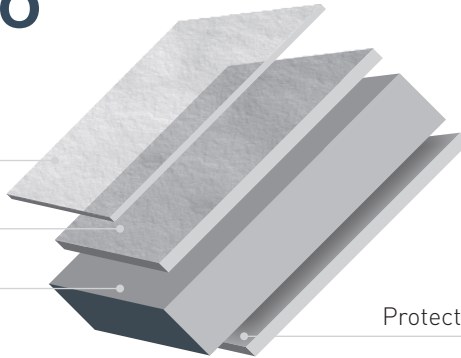

Aluminium STUCCO  
/MAT Coarse-grained

**STUCCO Aluminium** - is a uniquely shaped surface of sheet metal (orange peel), which makes it look exclusive, suppresses the sounds of rain better and ensures high comfort of use.



Ultra light – its density is only 2.7g/cm<sup>3</sup>, it allows to design a lighter building structure and to reduce the costs of construction.



100% renewable- ecological material, can be fully recycled, it does not lose its original properties during this process.



Strong and durable. Tensile strength of currently produced aluminum alloys is comparable to steel. Aluminum is resistant to severe weather conditions, which often makes it a natural choice for many applications.



Plastic – it is soft and easy to process by roofers. High plasticity allows to form almost any product from aluminum.



Corrosion resistant aluminum is automatically covered with a thin layer of oxygen which prevents further oxidation – it is being rebuilt.



**THUNDER**  
STONE ROOFING REVOLUTION







# BLIZZARD





**KROP<sup>®</sup>**

**GUTTER SYSTEMS**

**STEEL**



## DIMENSIONS AND COLOURS OF THE KROP STEEL GUTTER SYSTEM

Steel gutters go perfectly well with roofs made of the same material, are incredibly universal and match any type of roofing. Steel offers a solution that is not only aesthetic but also extremely durable and resistant. **KROP** steel gutters retain their performance characteristics in any weather conditions and are resistant to high temperatures.

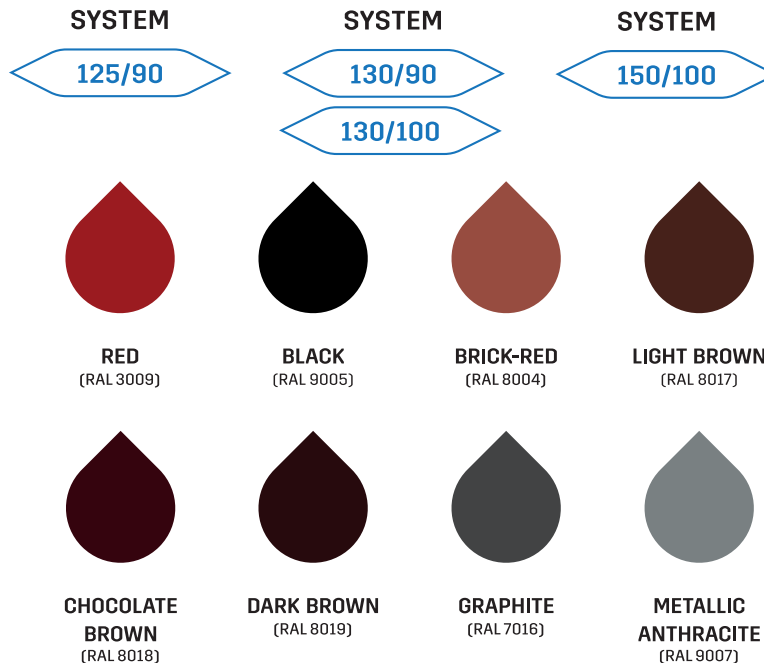





## KROP STEEL GUTTER CROSS-SECTION

**KROP** steel gutters are made of high-quality steel coated with four protective layers: zinc, passivation coating, undercoat, and organic layer. Steel material is coated both on the inner and the outer side of the gutter. Thanks to the protective layers, the steel gutter system is more resistant to harmful impact of weather conditions and more resistant to mechanical damage. Zinc - applied directly to steel, protects the material against corrosion. Passivation layer - ensures good adhesion of undercoat paint. Undercoat - enhances anti-corrosion properties and improves adhesion of the organic layer. Organic layer - ensures final resistance and aesthetic appearance of a steel gutter.

**ORGANIC COATING**

**UNDERCOAT LAYER**

**PASSIVATION LAYER**

**ZINC**

**STEEL**

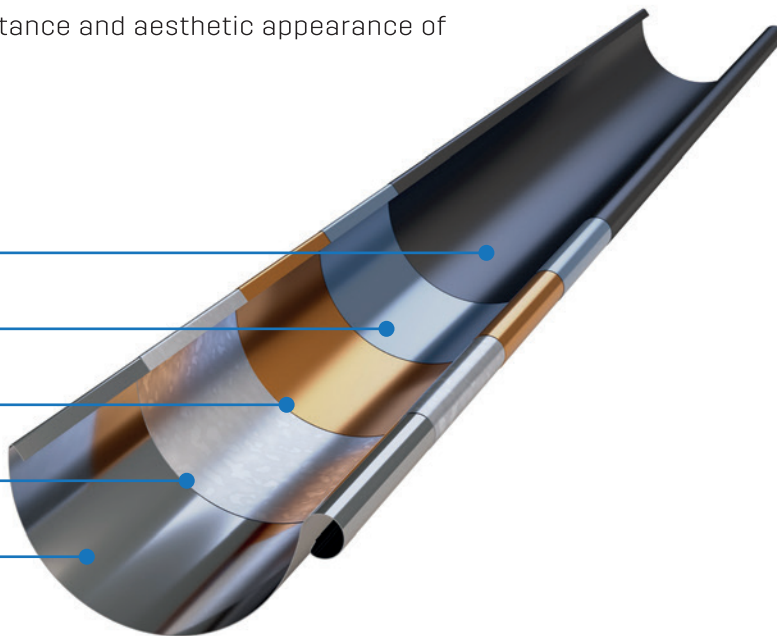



## STEEL



### **UP TO 40 YEARS OF WARRANTY**

Product with proven performance characteristics. It is one of the longest guarantee periods available on the market.



### **HIGH DURABILITY**

A very high quality material ensuring high resistance to mechanical damage and scratching.



### **PROTECTIVE LAYERS**

A steel gutter has four protective layers ensuring higher resistance to adverse weather conditions and resistance to mechanical damage.



### **CORROSION RESISTANCE**

Thanks to the use of top quality steel and protective layers, the system features very high corrosion-resistance.



## ADVANTAGES OF KROP STEEL SYSTEM



### **MECHANICAL RESISTANCE**

Based on tests and analyses, the product features very high resistance to mechanical damage.



### **EASY INSTALLATION**

The system designed with attention to detail enables quick and efficient installation. The solution has been designed in cooperation with roofers.



### **VERSATILITY**

Fits all types of roofing.



### **HIGH RESILIENCE**

Resistant to deformation under external conditions.

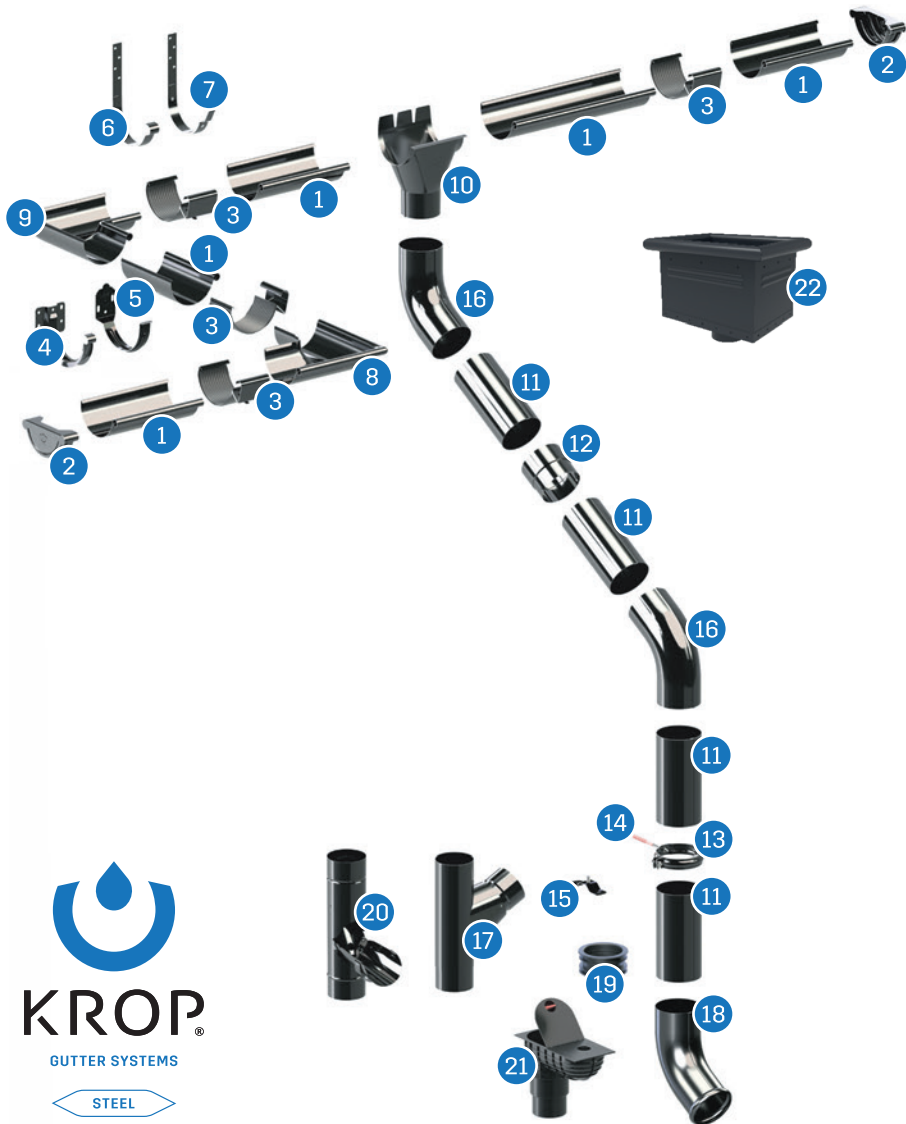





## KROP STEEL GUTTER SYSTEM COMPONENTS

1. Gutter
2. Universal bottom
3. Gutter connector
4. Butt hook
5. Butt hook of flat stock
6. Rafter hook
7. BB rafter hook
8. 90° External angle \*
9. 90° Internal angle\*
10. Drain funnel
11. Tube
12. Pipe joint
13. Pipe clamp
14. Clamp dowel
15. Clamp mounting to a layered panel
16. Elbow
17. Branch
18. Shoe
19. 90/110 Rubber reducer
20. Rainwater collector
21. Sedimentation tank/Universal sink box
22. Outlet basket

\* On special request, we make angles with any bending angle starting from 80°



1

## Gutter

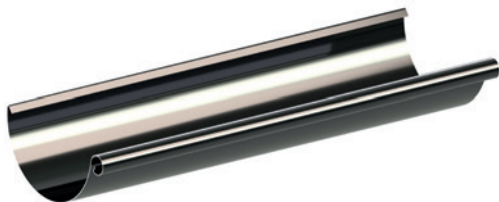

SYSTEM	W	LENGTH
125	4 <sup>23</sup> / <sub>32</sub> "	9.84 Ft 13.12 Ft
130	4 <sup>59</sup> / <sub>64</sub> "	9.84 Ft 13.12 Ft
150	5 <sup>29</sup> / <sub>32</sub> "	9.84 Ft 13.12 Ft

2

## Universal bottom



SYSTEM	W
125	6 <sup>19</sup> / <sub>64</sub> "
130	6 <sup>33</sup> / <sub>64</sub> "
150	7 <sup>31</sup> / <sub>64</sub> "

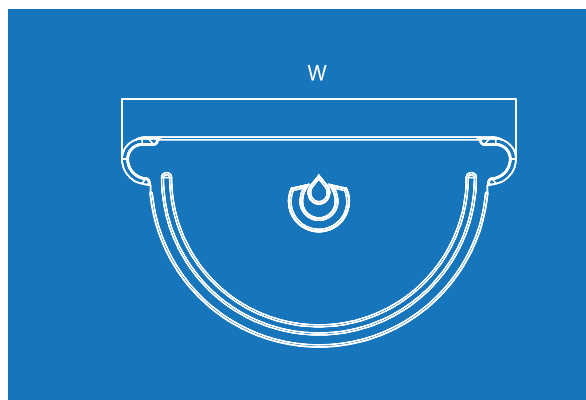
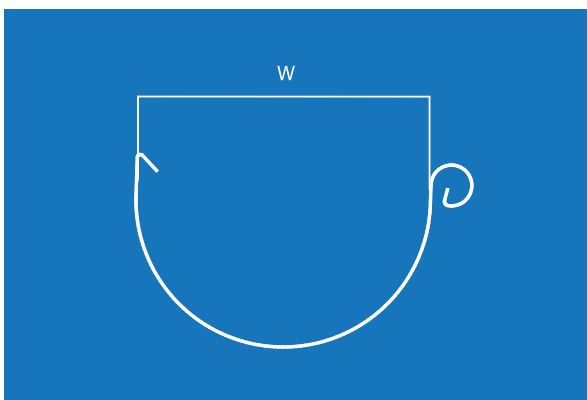



3

## Gutter connector

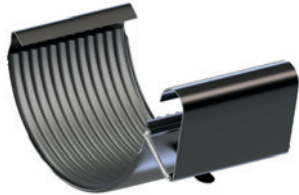

SYSTEM L

125	3 1/32 "
130	3 1/32 "
150	3 1/32 "

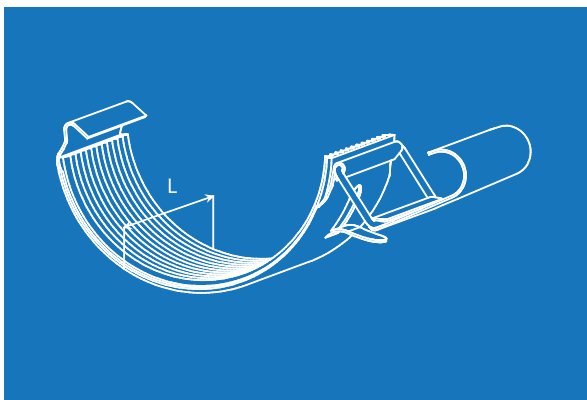

# KROP®

GUTTER SYSTEMS

STEEL



4

### Fascia bracket



SYSTEM H

125	4 <sup>3</sup> / <sub>32</sub> "
130	4 <sup>5</sup> / <sub>64</sub> "
150	5 <sup>23</sup> / <sub>64</sub> "

5

### Fascia bracket



SYSTEM H

130	4 <sup>5</sup> / <sub>64</sub> "
-----	----------------------------------

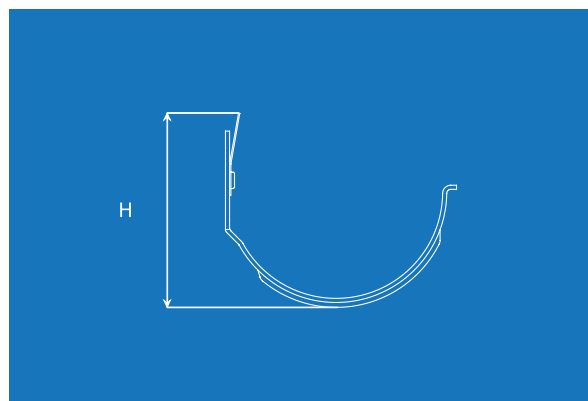
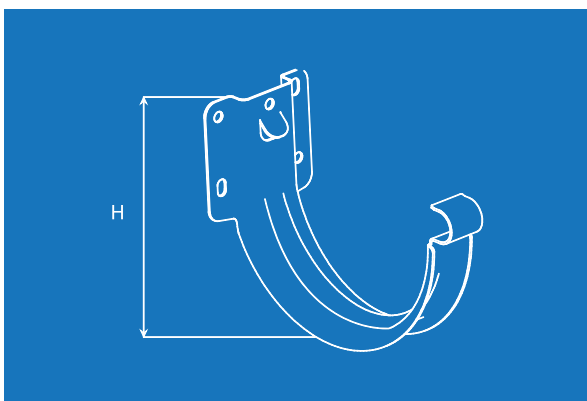



6

## Long bracket



SYSTEM H

125	9 <sup>29</sup> / <sub>64</sub> "
130	9 <sup>29</sup> / <sub>64</sub> "
150	9 <sup>29</sup> / <sub>64</sub> "

7

## BB bracket



SYSTEM H

130	11 <sup>13</sup> / <sub>16</sub> "
150	11 <sup>13</sup> / <sub>16</sub> "

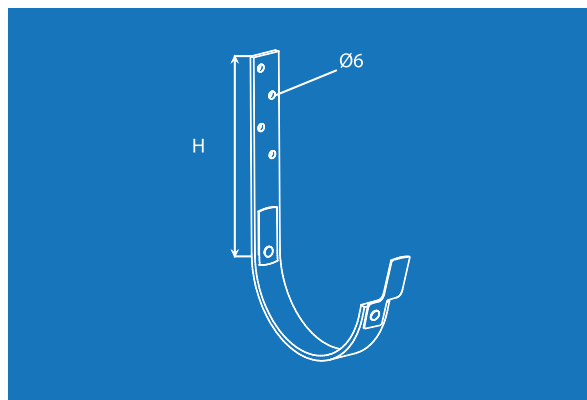
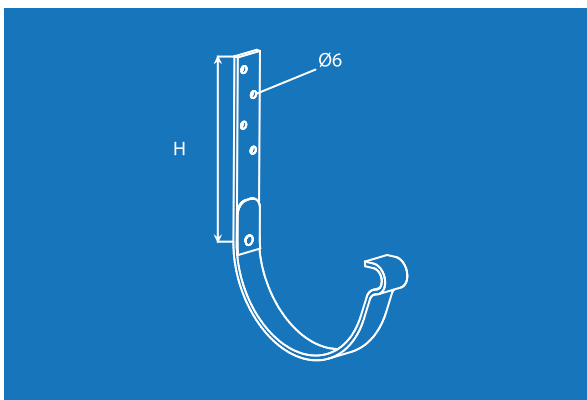



8

## 90° External angle

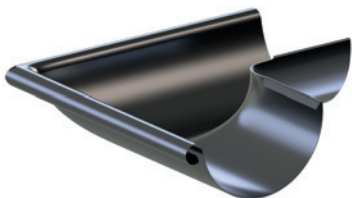

SYSTEM L

125	9 <sup>1</sup> / <sub>64</sub> "
130	9 <sup>1</sup> / <sub>64</sub> "
150	10 <sup>5</sup> / <sub>8</sub> "

9

## 90° Internal angle

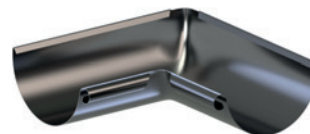

SYSTEM L

125	9 <sup>1</sup> / <sub>16</sub> "
130	9 <sup>1</sup> / <sub>16</sub> "
150	10 <sup>3</sup> / <sub>64</sub> "

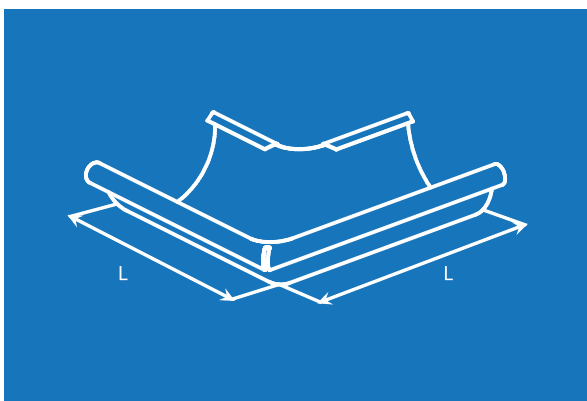

\* On special request, we make angles with any bending angle starting from 80°

\* On special request, we make angles with any bending angle starting from 80°



## 10 Outlet



SYSTEM D

125	$\varnothing 3^{13/32}$ "
130	$\varnothing 3^{13/32}$ "
130	$\varnothing 3^{5/16}$ "
150	$\varnothing 3^{5/16}$ "

## 11 Downpipe



SYSTEM D LENGTH

90	$\varnothing 3^{15/16}$ "	3.28 Ft
100	$\varnothing 4$ "	9.84 Ft
		13.12 Ft

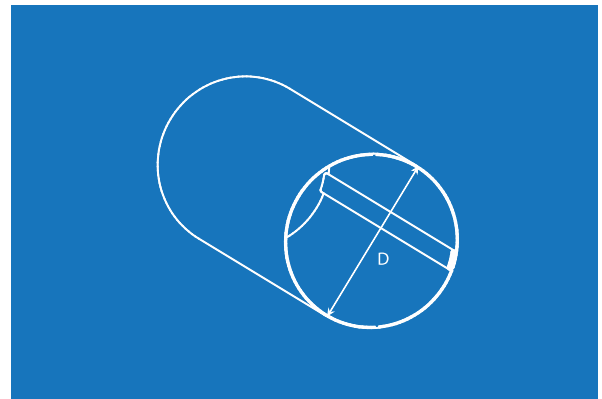
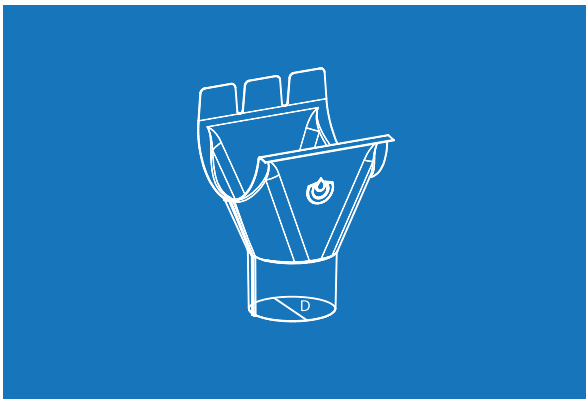



12

## Pipe connector



SYSTEM	D1	D2
90	Ø3 <sup>15</sup> / <sub>32</sub> "	Ø3 <sup>23</sup> / <sub>64</sub> "
100	Ø4 <sup>1</sup> / <sub>64</sub> "	Ø3 <sup>7</sup> / <sub>8</sub> "

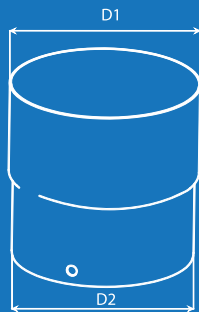

13

## Pipe clamp



SYSTEM	D
90	Ø3 <sup>31</sup> / <sub>64</sub> "
100	Ø4 <sup>1</sup> / <sub>64</sub> "

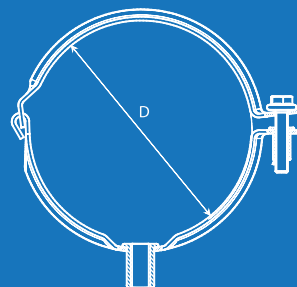





### 14 Clamp dowel



D1

D2

L

$\frac{5}{16}$ "	$1\frac{5}{32}$ "	$3\frac{15}{16}$ ", $7\frac{9}{32}$ ", $7\frac{7}{8}$ ", $10\frac{15}{64}$ ", $11\frac{1}{16}$ "
------------------	-------------------	---

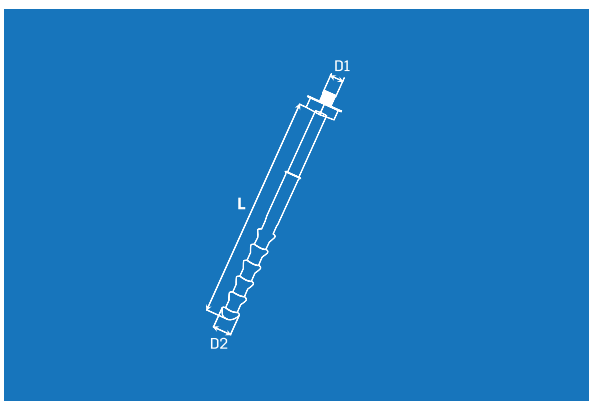

### 15 Clamp mounting to a layered panel



D

L

M8	$3\frac{17}{64}$ "
----	--------------------

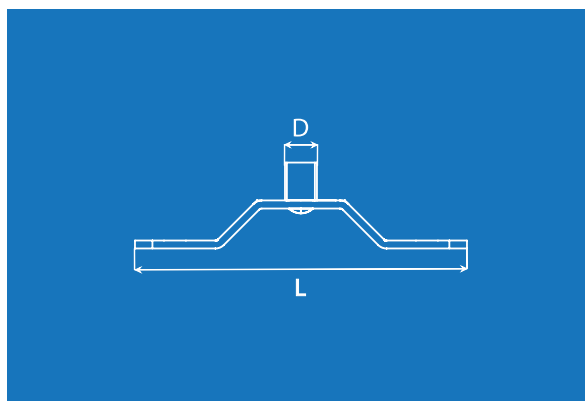



16

## Elbow



SYSTEM ANGLE

90	60°
100	60°

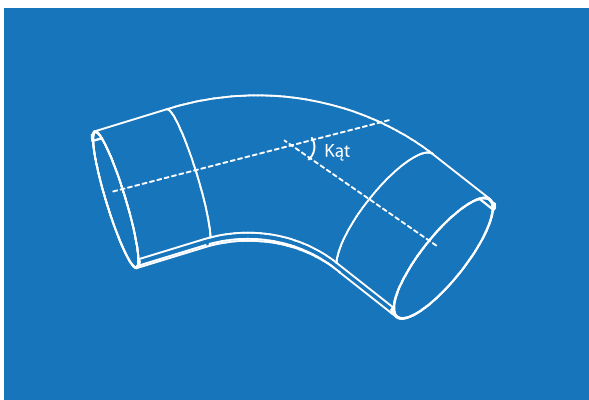

17

## Branch



SYSTEM H ANGLE

90	11 <sup>13</sup> / <sub>16</sub> "	67,5°
100	11 <sup>13</sup> / <sub>16</sub> "	67,5°

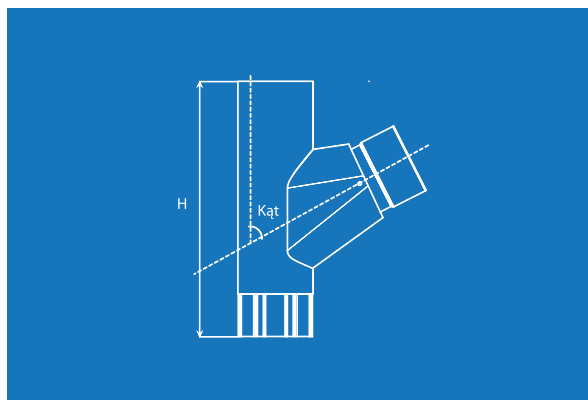



18 Shoe



SYSTEM ANGLE

SYSTEM	ANGLE
90	60°
100	60°

19 90/110 Rubber reducer

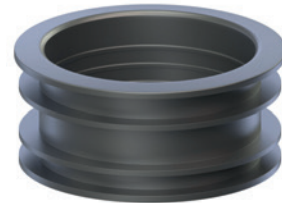

D1 D2

$3\frac{35}{64}$ "	$4\frac{21}{64}$ "
--------------------	--------------------

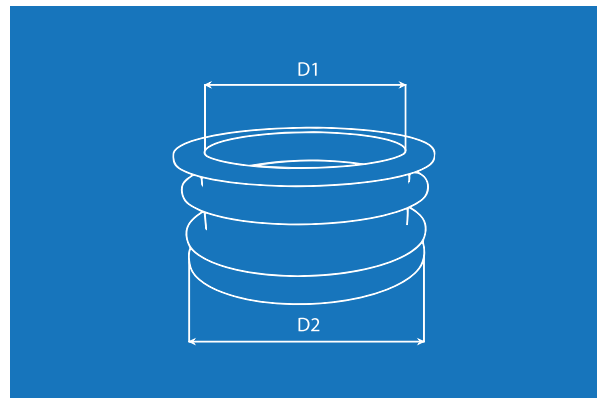
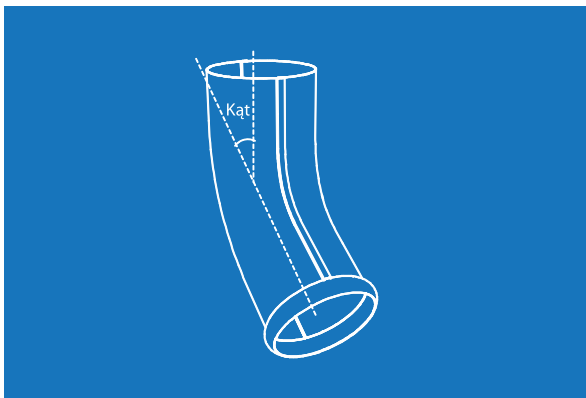



20

## Rainwater collector



SYSTEM H

90	14 <sup>51</sup> / <sub>64</sub> "
100	14 <sup>51</sup> / <sub>64</sub> "

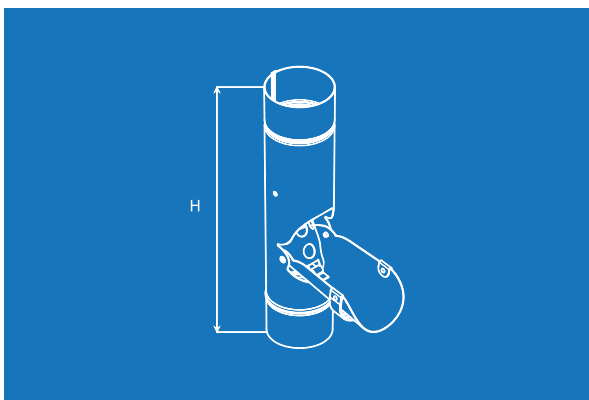

21

## Sedimentation tank / Universal sink box \*

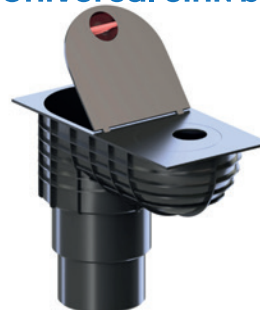

SYSTEM L H W D

63	12 <sup>23</sup> / <sub>32</sub> "	10 <sup>13</sup> / <sub>64</sub> "	6 <sup>19</sup> / <sub>64</sub> "	4 <sup>21</sup> / <sub>64</sub> "
90	12 <sup>23</sup> / <sub>32</sub> "	10 <sup>13</sup> / <sub>64</sub> "	6 <sup>19</sup> / <sub>64</sub> "	4 <sup>21</sup> / <sub>64</sub> "

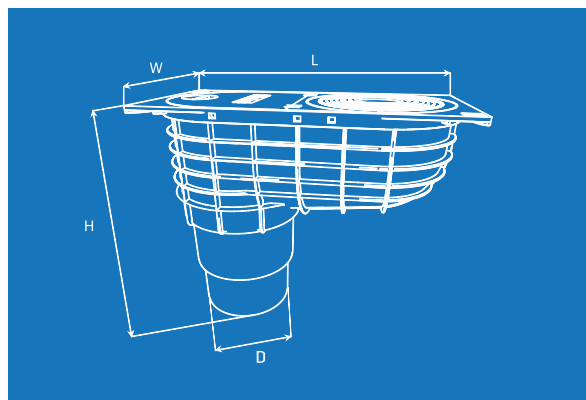

\* Component available in RAL 7016, 8017, 9005 colours



22

## Outlet basket



SYSTEM	L	H	W	D
90	9 <sup>29</sup> / <sub>64</sub> "	7 <sup>7</sup> / <sub>8</sub> "	7 <sup>31</sup> / <sub>64</sub> "	Ø3 <sup>15</sup> / <sub>16</sub> "
100	9 <sup>29</sup> / <sub>64</sub> "	7 <sup>7</sup> / <sub>8</sub> "	7 <sup>31</sup> / <sub>64</sub> "	Ø3 <sup>15</sup> / <sub>16</sub> "

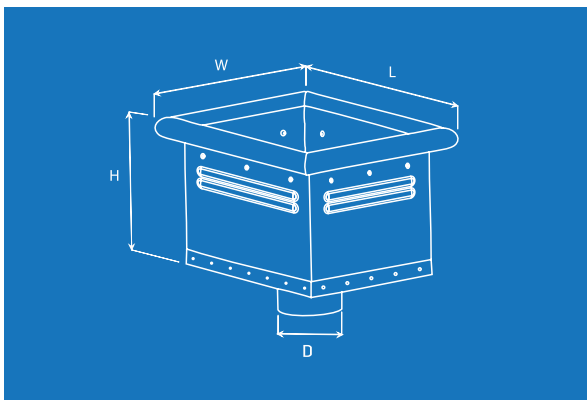

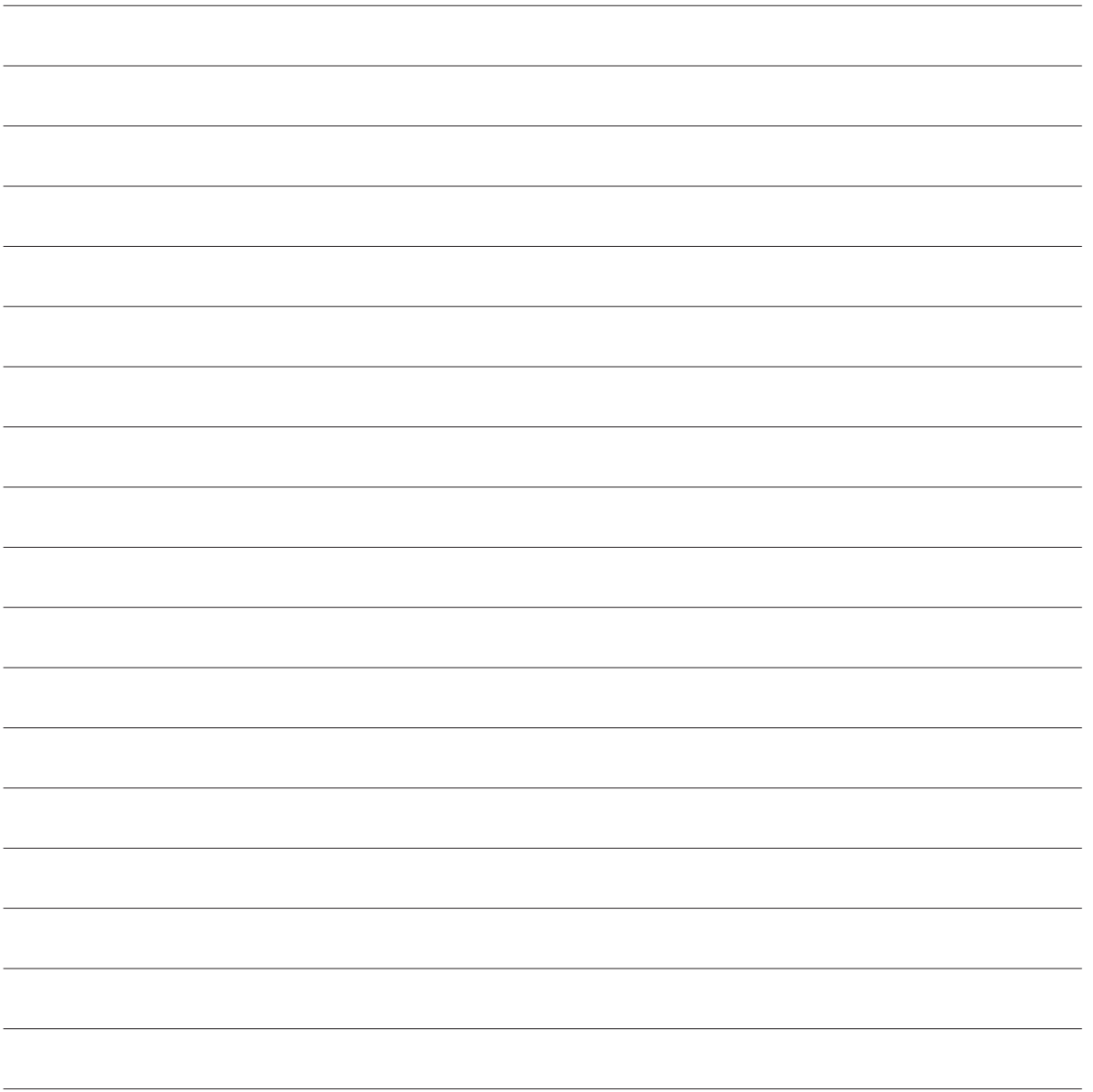

# The Best Type of Roofing

